

Features

- Metal pop-up drain with tailpiece
- 6-5/8" (168 mm) spout reach
- Includes stationary spout with aerator and pop-up drain with 1¼" tailpiece
- Handles sold separately
- Laminar flow delivers a graceful stream of water
- 1.2 gpm (4.5 lpm) maximum flow rate
- Coordinate with your choice of Artifacts handles for a personalized design

Material

- Brass
- KOHLER finishes resist corrosion and tarnishing

Installation

- Widespread

Water Conservation & Rebates

- This product can help a building earn Water Efficiency points in LEED™ Green Building Rating System



Codes/Standards







ASME A112.18.1/CSA B125.1
NSF/ANSI/CAN 61
NSF/ANSI/CAN 372
All applicable US Federal and State material regulations
DOE - Energy Policy Act 1992
EPA WaterSense™
California Energy Commission (CEC)

KOHLER® Faucet Lifetime Limited Warranty

See website for detailed warranty information.

Available Colors/Finishes

Color tiles intended for reference only.

Color	Code	Description
	CP	Polished Chrome
	SN	Vibrant™ Polished Nickel
	BN	Vibrant™ Brushed Nickel
	BV	Vibrant™ Brushed Bronze
	2BZ	Oil-Rubbed Bronze
	2MB	Vibrant™ Brushed Moderne Brass

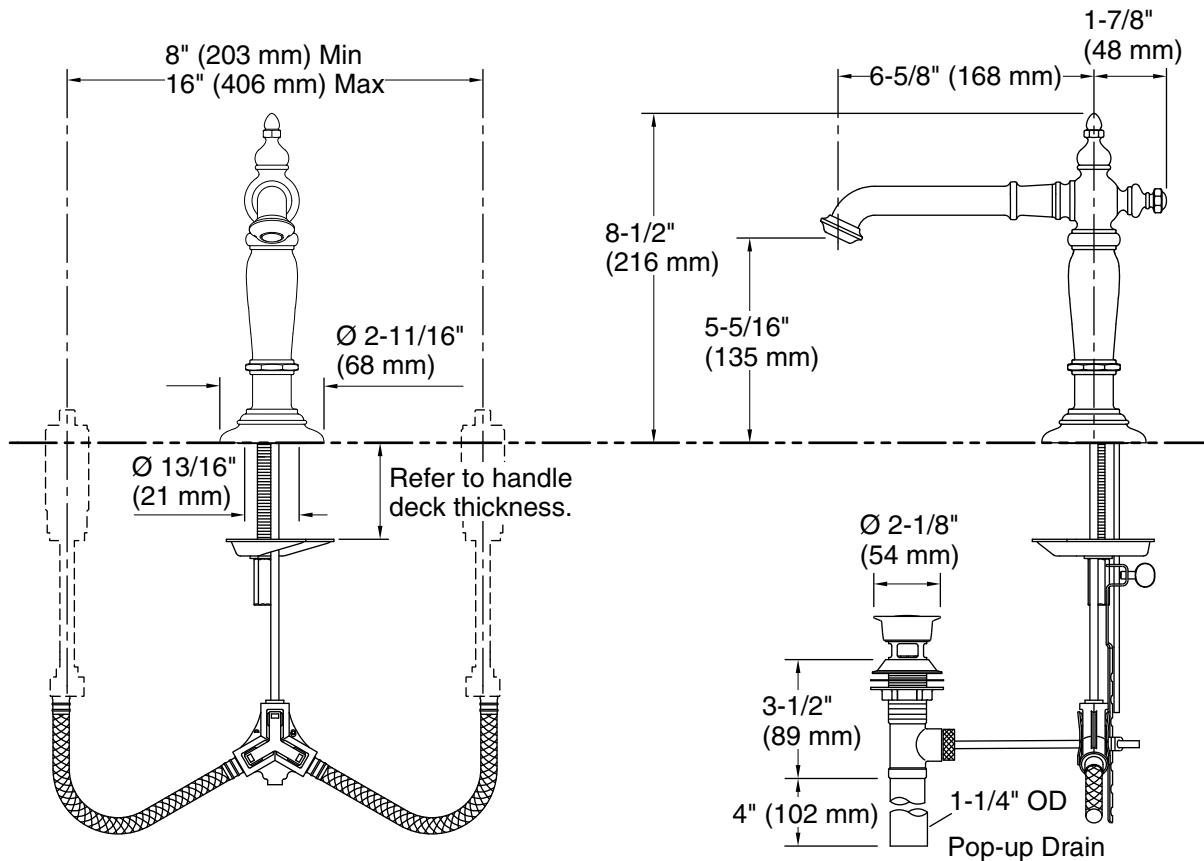

Technical Information

All product dimensions are nominal.

Faucet:

Flow rate: 1.2 gal/min (4.5 l/min)

Pressure: 60 psi (4.1 bar)

Drain included: Yes

Spout:

Spout reach: 6-5/8" (168 mm)

Notes

Install this product according to the installation guide.